

## DLPlus Mini-Trunking

Number(s) : 0 300 04/07/08/10/14/15/21/22/26/27/33, 0 302 07 to 0 302 16/18/21/23/24/26/27/28/41/43/51/53/54/74/81/83/86/88/90 to 0 302 93, 0 301 10/12/14/91/93, 0 306 54/67, 0 303 00/03/16/26, 0 312 00 to 0 312 08/11/13/14, 0 333 01/10/11/16/17/21/30, 0 336 00 to 09, 0 308 01/04/05

CONTENTS	PAGES
1.Range	1 to 2
2.Accessories	3 to 7
3.Wiring accessories frames	8
4.Material characteristics	9
5.Technical characteristics	9 to 10

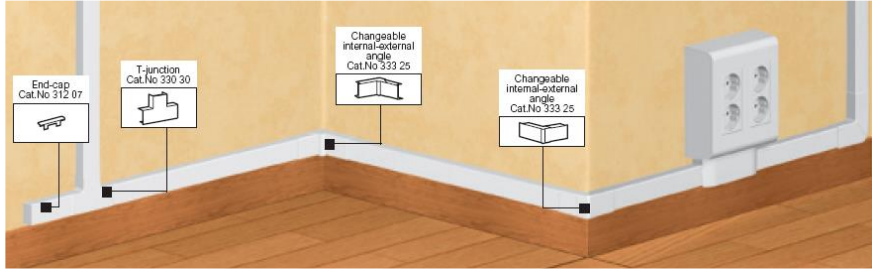

### 1. RANGE

DLP mini-trunking offers:

- the distribution, the protection and the derivation of various cables in an electrical installation.
- mini-trunkings, finishing accessories (end, joint of lid, joint of body, interior angle, exterior angle, flat angle, derivation)
- all the easy ways/advantages for the installation.
- to comply with the norm EN 50085-2-1, safety and technical performance.
- a flexibility with the installation and maintenance:

DLPlus mini-trunking with cable grip:

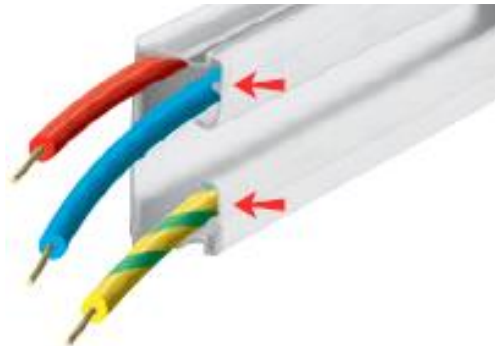

Equipped with a integrated device for holding cables in place

Without central partition

With central partition

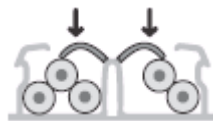
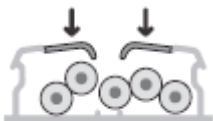

Cable grip :

It makes the installation easier and faster by containing all the wires inside the trunking body before the cover is clipped.

Comfortable implementation:

During installation, the conductors stay in place in the 1 or 2 compartment mini-trunking thanks to cable-grip membranes.

Speed of installation:

- cable holding is integrated with the trunking (no staple to add)
- easy conductors position
- quick cover fitting

### 1. RANGE (continued)

Export range :

Sections	references	Pack
20x12.5 a/c	0 300 07	120m
20x12.5 s/c	0 300 08	120m
32x12.5 a/c	0 300 14	80m
32x12.5 s/c	0 300 15	80m
32x16 s/c	0 308 04	60m
40x20 s/c	0 300 27	48m
60x20 a/c	0 301 14	32m
75x20 a/c	0 300 33	20m

Sections	references	Pack
20x10 a/c	0 308 01	120m
20x10 s/c	0 308 02	120m
32x10 a/c	0 308 05	90m
16x16 s/c	0 300 04	80m
25x16 s/c	0 300 10	80m
40x16 s/c	0 300 22	90m
60x16 a/c	0 300 26	90m
32x25 s/c	0 301 12	60m
40x25 s/c	0 301 10	60m

Note : a/c = with central partition, s/c = without central partition

## 1. RANGE (continued)

1.1. Mini-trunking without central partition ref. 0 300 04/08/10/15/22/27, 0 308 02/04, 0 301 10/12



Assembly of the body and covers by clips (disassembling with the assistance tool ex: screwdriver)

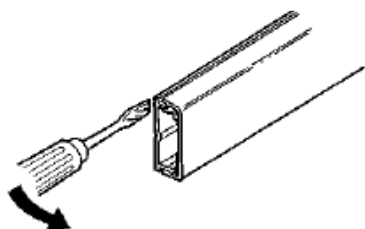

1.2. Mini-trunking with central partition ref. 30007/14/21/26/33 and 0 301 14, 0 308 01/05



Assembly of the body and covers by clips (disassembling with the assistance tool ex: screwdriver)

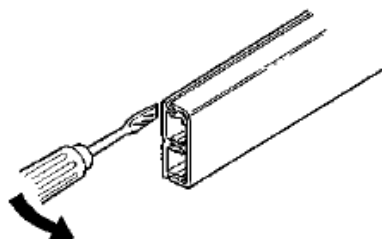

Available in length of 2m.  
White color RAL 9003

Fixing by:  
- joining (cartridge of adhesive neoprene for glue gun ref. 30949)  
- wall plugs for immediate fixing (without screw nor nail ref. 0 308 98/99)  
- screw, nails...

## 2. ACCESSORIES

2.1. End cap ref. 0 312 00/01/02/03/04/05/06/07/08/09/11/13/14, 0 302 90 and 0 303 00.

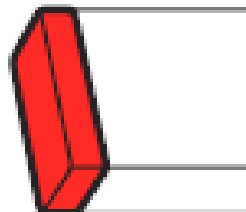

White color RAL 9003

Allows to block the end of the body:

- respect of the protection degree
- improvement of aesthetics (covering of the cut)
- left or right end cap

Assembly on the body by fitment and screwing.

References	Use with mini-trunking	pack
0 312 00	20x10	10
0 312 01	32x10	10
0 312 02	20x12.5	20
0 312 03	32x12.5	20
0 312 05	16x16	10
0 312 06	25x16	10
0 312 07	32x16	10
0 312 08	40x16	10
0 312 11	40x20	10
0 312 13	32x25	10
0 312 14	40x25	10
0 302 90	60x16/20	10
0 303 00	75x20	10

## DLPlus Mini-Trunking

Number(s) : 0 300 04/07/08/10/14/15/21/22/26/27/33, 0 302 07 to 0 302 16/18/21/23/24/26/27/28/41/43/51/53/54/74/81/83/86/88/90 to 0 302 93, 0 301 10/12/14/91/93, 0 306 54/67, 0 303 00/03/16/26, 0 312 00 to 0 312 08/11/13/14, 0 333 01/10/11/16/17/21/30, 0 336 00 to 09, 0 308 01/04/05

### 2. ACCESSORIES (continued)

2.2. Internal/external angle ref. 0 302 21/51/71/81/91/92, 0 333 15/25/26 and 0 303 01/02.

References	Use with mini-trunking	pack
0 302 11	20x10	20
0 302 51	32x10	10
0 302 21	20x12.5	10
0 302 51	32x12.5	10
0 301 91	16x16	10
0 302 41	25x16	10
0 333 25	32x16	10
0 333 26	40x16	10
0 302 81	40x20	10
0 333 55	32x25	10
0 302 86	40x25	10
0 302 91/92	60x16/20	10
0 303 01/02	75x20	10

Note :

Concerning mini-trunkings ref. 0 301 14 and 0 300 33, the internal/external angles have forms different that those from the other ref. of mouldings allowing screwing in the partitions.

The external angles are specific.

0 302 92 external angle for 60x20  
0 303 02 external angle for 75x20

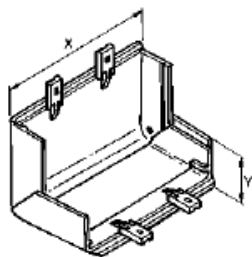

The internal angles are specific.

0 302 91 internal angle 60x20  
0 3030 01 internal angle 75x20

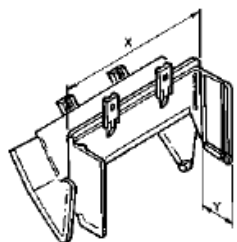

### 2. ACCESSORIES (continued)

2.2. Internal/external angle ref. 0 302 21/51/71/81/91/92, 0 333 15/25/26 and 0 303 01/02 (continued)

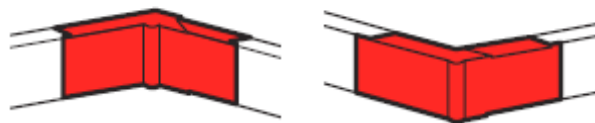

Internal/external angle allows:

- avoid the cut of miter on the mini-trunking
- respect of the degree protection
- aesthetics improves (covering of the cut and not or little extra thickness)

Assembly on the body by clipsage.

Variable internal/external angles of 60 with 120°.

White color RAL 9003

Assembly in internal angle :

For 60°

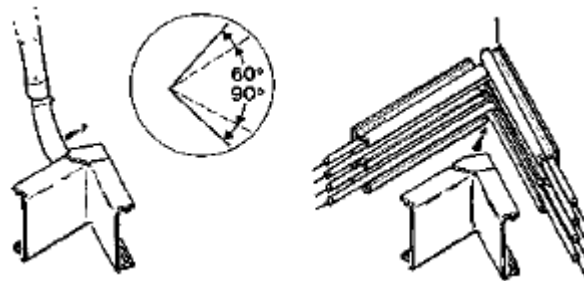

For 90°

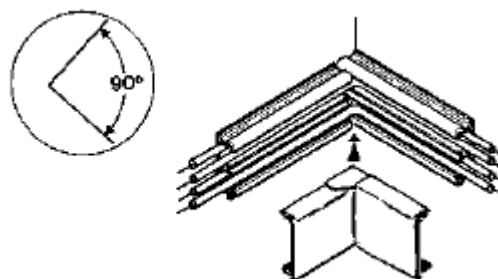

For 120°

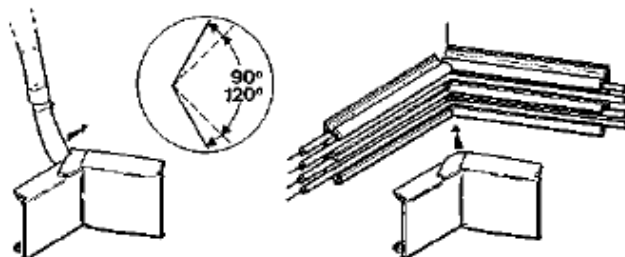

## 2. ACCESSORIES (continued)

2.2. Internal/external angle ref. 0 302 21/51/71/81/91/92, 0 333 15/25/26 and 0 303 01/02 (continued)

Assembly in internal angle :

For 60°

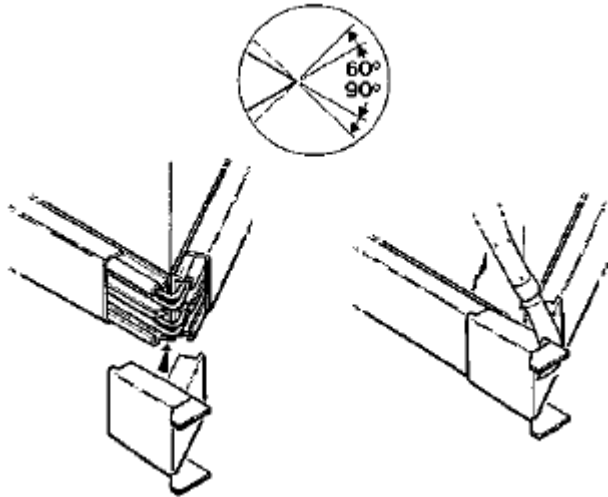

For 90°

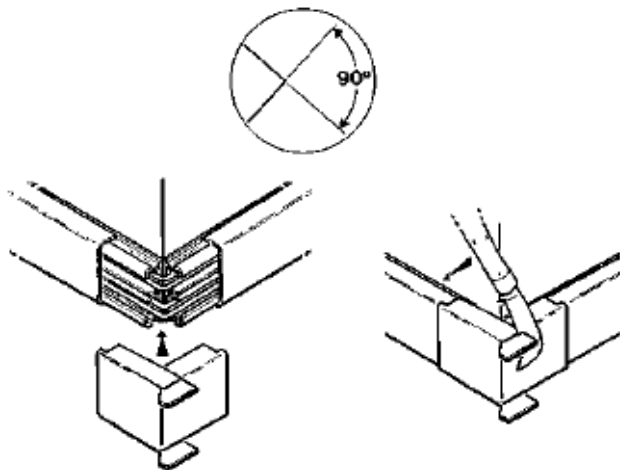

For 120°

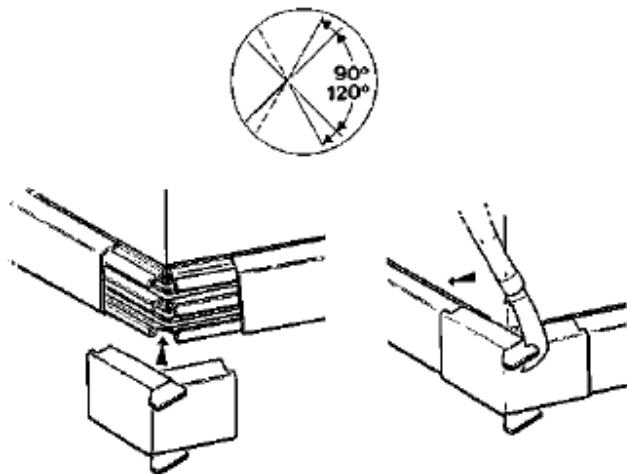

## 2. ACCESSORIES (continued)

2.3. Flat angle plat ref. 0 302 23/53/73/83/93, 0 333 16/27/28 and 0 303 03.

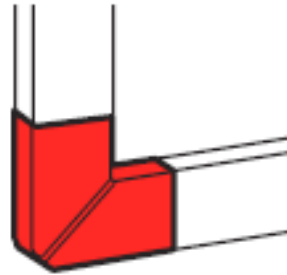

White color RAL 9003

The junction in flat angle of two same sections allows:

- avoid the cut of miter on the trunking
  - respect of the degree protection
  - the distribution of the various currents preserves
  - aesthetics (covering of the cut) improves
- Assembly on the body by clipsage.

Flat angles are variable (85° to 95°)

References	Use with mini-trunking	pack
0 302 13	20x10	20
/	32x10	/
0 302 23	20x12.5	10
0 302 53	32x12.5	10
0 301 93	16x16	10
0 302 43	25x16	10
0 333 27	32x16	10
0 333 28	40x16	10
0 302 83	40x20	10
0 333 57	32x25	10
0 302 88	40x25	10
0 302 93	60x16/20	10
0 303 03	75x20	10

Note :

Concerning mini-trunkings ref. 0 301 14 and 0 300 33, the flat angles have forms different that those from the other ref. of mouldings allowing screwing in the partitions.

The flat angles are specific.

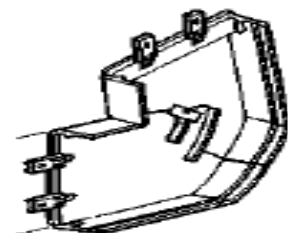

0 302 93 flat angle for 60x20  
0 303 03 flat angle for 75x20

## 2. ACCESSORIES (continued)

2.4. Cover joint ref. 0 336 00/01/02/03/04/06/07/08/09

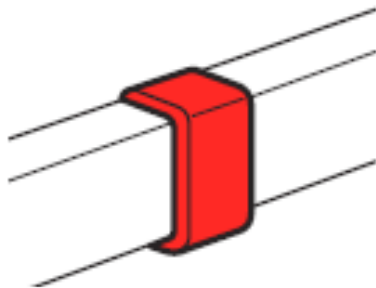

White color RAL 9003

Allows:

- the junction end to end of two covers
- respect of the degree protection
- to improve aesthetics (covering of the cut)

To put the cover joint on DLPlus, you can clip it on one cover (with 3 plastics part under cover joint for example with ref 0 336 09) after you can slide the others cover on cover joint and fix them on the base of mini-trunking.

References	Use with mini-trunking	pack
0 336 00	16x16	20
0 336 01	25x16	20
0 336 02	20x10/12.5	20
0 336 03	32x10/12.5	20
0 336 04	32x16	20
0 336 05	32x25	10
0 336 06	40x16/20	20
0 336 07	40x25	10
0 336 08	60x16/20	10
0 336 09	75x20	20

## 2. ACCESSORIES (continued)

2.5. Flat T junction ref. 0 302 07/08/09/18/24/27/28/54/74 and 0 333 30.

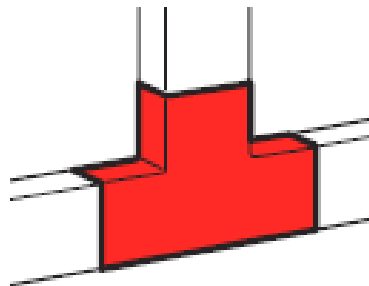

White color RAL 9003

The junction in "T" allows.

- respect of the degree protection
- aesthetics (covering of the cut) improves Assembly on the body by clipsage

References	Use with mini-trunking	pack
0 302 07	40x12.5/16	10
0 302 08	40x20	10
0 302 09	60x16/20	10
0 302 14	20x10	10
0 302 18	75x20	10
0 302 24	20x12.5	10
0 302 27	32x25	10
0 302 28	40x25	10
0 302 54	32x10/12.5	10
0 333 30	32x16	10

## 2. ACCESSORIES (continued)

2.6. Plug-in ceiling rose ref. 0 306 54.

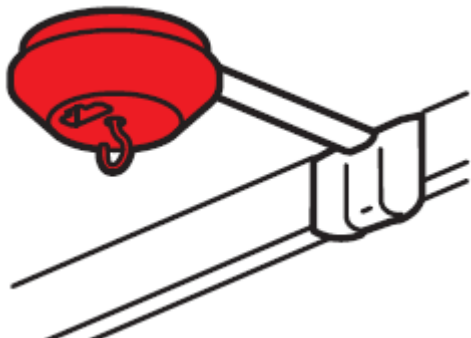

Connection of luminaires

Assembly on the ceiling by screwing

- respect of the degree protection
- to improve aesthetics (covering of the cut)

White color RAL 9003

Delivered with :

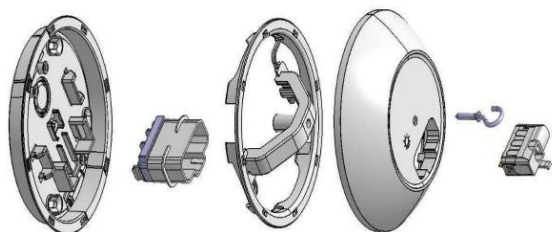

Hole cutter diameter 100mm

Height 40mm

Junction with linkings piece and mini-trunking:

- mini-trunking 20x10 DLPlus
- mini-trunking 20x12.5 DLPlus
- linking piece 32x8 ref. 0 306 67
- linking piece 32x9 ref. 0 190 10

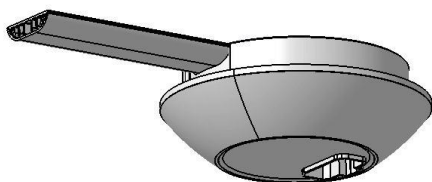

Maximum suspended weight : 25 Kg as long as unit is equipped with a suitable fixing device

Pack by 10

## 2. ACCESSORIES (continued)

2.7. Linking piece ref. 0 306 67.

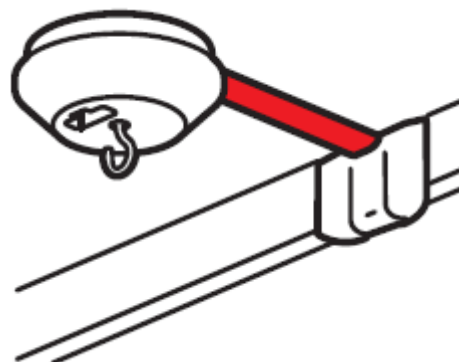

Length of 3m.

White color RAL 9003

Linking piece between the above unit and the ring trunking

Adhesive foam mounting: foam base equipped with a self-adhesive

It makes the installation easier and faster by containing all the wires (4 conductors) inside the body before the cover is clipped.

Fixing by:

- joining (cartridge of adhesive neoprene for glue gun ref. 0 309 49)
- wall plugs for immediate fixing (without screw nor nail ref. 0 308 98/99)
- screw, nails...

Assembly of the body and covers by clips (disassembling with the assistance tool ex: screwdriver)

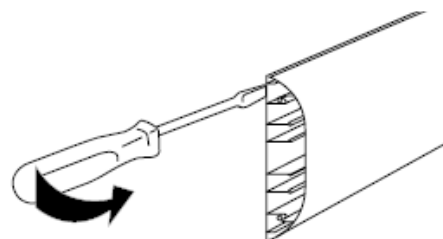

Dimensions.

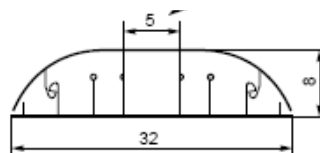

## 2. ACCESSORIES (continued)

2.8. Wall and ceiling tap-off ref. 0 302 16/26 et 0 333 17/29.

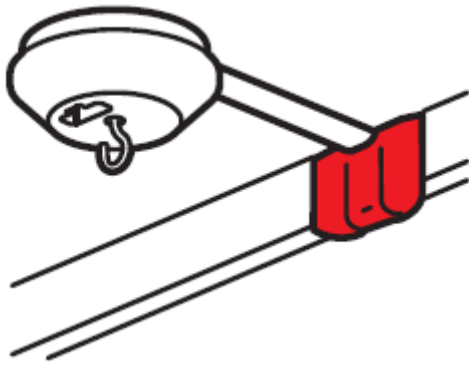

Differents installation with the wall and ceiling tap-off :

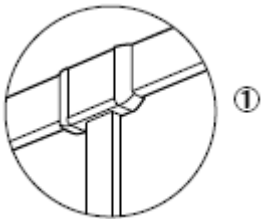

1. Junction in T

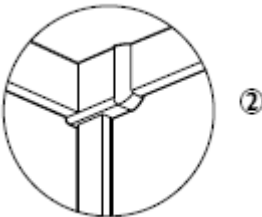

2. Junction in angle

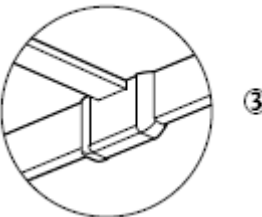

3. Junction on the ceiling

White color RAL 9003

The junction allows.

- respect of the degree protection
- aesthetics (covering of the cut) improves

Assembly on the body by clipsage and on the wall by screwing

References	Use with mini-trunking
0 302 16	0 300 27
0 302 26	0 300 33/0 301 14
0 333 17	0 300 14/15
0 333 29	0 308 04/0 300 21

## 2. ACCESSORIES (continued)

2.9. Height spacer ref. 0 306 77.



Color RAL 8014

Available in length of 2.10m, colour: charcoal grey.  
Allows to use the mini-trunking on the ground  
Assembly with adhesive

2.10. Junction boxes ref. 0 303 16/26

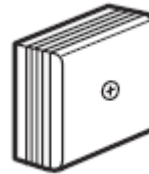

Allows:

- the junction on 4 directions
- respect of the degree protection
- to improve aesthetics (covering of the cut)

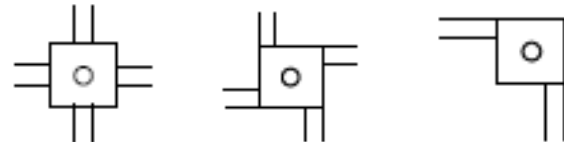

White color RAL 9003

Dimensions.

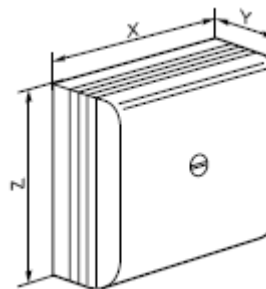

References	X(mm)	Y(mm)	Z(mm)
0 303 16	75	35	75
0 303 26	110	50	110



3. WIRING ACCESSORIES FRAMES

DLPlus mini-trunking: wiring accessories frames

BODIES	Mosaic frames											
	Installation at the end of the mini-trunking <sup>(1)</sup>						Installation alongside the mini-trunking <sup>(1)</sup>					
	2 modules <sup>(2)</sup>	3 modules	4 modules <sup>(3)</sup>	6 modules <sup>(3)</sup>	2 x 4 modules <sup>(3)</sup>	3 x 4 modules <sup>(3)</sup>	2 modules <sup>(2)</sup>	3 modules <sup>(2)</sup>	4 modules <sup>(3)</sup>	6 modules <sup>(3)</sup>	2 x 4 modules <sup>(3)</sup>	3 x 4 modules <sup>(3)</sup>
	1 frame + 1 adaptor						1 frame + 1 adaptor					
<b>20 x 12.5</b>	316 11 316 40	316 12 316 40	316 13 316 40	316 14 316 40	316 21 316 40	316 22 316 40	316 11 317 01	316 12 317 01	316 13 317 02	316 14 317 03	316 21 317 02	316 22 317 03
<b>32 x 12.5</b>	316 11 316 41	316 12 316 41	316 13 316 41	316 14 316 41	316 21 316 41	316 22 316 41	316 11 317 01	316 12 317 01	316 13 317 02	316 14 317 03	316 21 317 02	316 22 317 03
<b>32 x 16</b>	316 11 316 41	316 12 316 41	316 13 316 41	316 14 316 41	316 21 316 41	316 22 316 41	316 11 317 04	316 12 317 04	316 13 317 05	316 14 317 06	316 21 317 05	316 22 317 06
<b>40 x 20</b>	316 11 316 47	316 12 316 47	316 13 316 47	316 14 316 47	316 21 316 47	316 22 316 47	316 11 317 07	316 12 317 07	316 13 317 08	316 14 317 09	316 21 317 08	316 22 317 09
<b>60 x 20</b>	316 11 316 45	316 12 316 45	316 13 316 45	316 14 316 45	316 21 316 45	316 22 316 45	316 11 317 07	316 12 317 07	316 13 317 08	316 14 317 09	316 21 317 08	316 22 317 09
<b>75 x 20</b>	-	-	316 13 316 48	316 14 316 48	316 21 316 48	316 22 316 48	316 11 317 07	316 12 317 07	316 13 317 08	316 14 317 09	316 21 317 08	316 22 317 09

(1) Use with Mosaic socket outlets  
 (2) Frame dimensions: 127 x 74 x 60 mm  
 (3) Frame dimensions: 149 x 74 x 60 mm  
 (4) Frame dimensions: 172 x 74 x 60 mm  
 (5) Frame dimensions: 217 x 74 x 60 mm  
 (6) Frame dimensions: 162 x 167 x 60 mm  
 (7) Frame dimensions: 226 x 167 x 60 mm

BODIES	Special surface mounting frames for wiring accessories (p. 859)		Surface mounting frames for 60 mm fixing centres wiring accessories		
	Installation alongside the mini-trunking		Installation alongside the mini-trunking		
	1 gang for horizontal or vertical	2 gang for horizontal or vertical	1 gang for horizontal or vertical	2 gang for horizontal or vertical	3 gang for horizontal or vertical
<b>20 x 12.5</b>	314 04	314 14	316 94	316 95	316 96
<b>32 x 12.5</b>	314 04	314 14	316 94	316 95	316 96
<b>32 x 16</b>	314 56	314 66	316 94	316 95	316 96
<b>40 x 20</b>	314 08	314 18	316 94	316 95	316 96
<b>60 x 20</b>	314 08	314 18	316 94	316 95	316 96
<b>75 x 20</b>	314 08	314 18	316 94	316 95	316 96



**4. MATERIAL CHARACTERISTICS**

The trunkings, covers and partitions are in PVC white RAL 9003.

Plastic accessories:

The accessories are in plastic ABS or PVC white RAL 9003

**5. TECHNICAL CHARACTERISTICS**

Wiring capacity :

Conductors types : HO7V-K (norm NFC 32-201)

Dimensions (mm)	Reference	Number of compartments	Cross-section (mm <sup>2</sup> )	Ø max mm
20*12.5	0 300 08	1	160	10
32*12.5	0 300 15	1	285	2 x 10
32*16	0 308 04	1	360	13
40*20	0 300 27	1	580	17
20*12.5	0 300 07	1	70	6,5
		2	70	6,5
32*12.5	0 300 14	1	120	10
		2	120	10
60*20	0 301 14	1	200	12,5
		2	200	12,5
		3	320	17
75*20	0 300 33	1	290	17
		2	290	17
		3	445	2 x 12

**5. TECHNICAL CHARACTERISTICS (continued)**

Classification for DLPlus mini-trunking EN 50085-2-1.

6.2 Resistance to impact for installation and application	2.0J
6.3 Minimum storage and transport temperature	- 25°C
6.3 Minimum installation and application temperature	- 5°C
6.3 Maximum application temperature	+ 60°C
6.4 Resistance to flame propagation	Non-flame propagating
6.5 Electrical continuity characteristic	Without electrical continuity characteristic
6.6 Electrical insulating characteristic	With electrical insulating characteristic
6.7 Degrees of protection provided by enclosure	IP40
6.9 The system access cover retention	With a tool
6.101 The position when surface mounted	Wall fixed Ceiling fixed
6.102 The functions provided	Type 1
Rated current	500 V
Protection against mechanical shocks	IK 07

Compositions and functions of DLPlus mini-trunking systems EN 50085-2-1 :

Body/cover	Mini-trunking		End cap
	references	Section (mm <sup>2</sup> )	
20x12.5 a/c	0 300 07	70/70	0 312 02
20x12.5 s/c	0 300 08	160	0 312 02
32x12.5 a/c	0 300 14	120/120	0 312 03
32x12.5 s/c	0 300 15	285	0 312 03
32x16 s/c	0 308 04	360	0 312 07
40x20 s/c	0 300 27	580	0 312 11
60x20 a/c	0 301 14	200/320/200	0 302 90
75x20 a/c	0 300 33	290/445/290	0 303 00
20x10 a/c	0 308 01	50/50	0 312 00
20x10 s/c	0 308 02	110	0 312 00
32x10 a/c	0 308 05	90/90	0 312 01
16x16 s/c	0 300 04	120	0 312 05
25x16 s/c	0 300 10	190	0 312 06
40x16 s/c	0 300 22	400	0 312 08
60x16 a/c	0 300 26	155/270/155	0 302 90
32x25 s/c	0 301 12	560	0 312 13
40x25 s/c	0 301 10	740	0 312 14